

Amana® Commercial

Project #: _____

Item #: _____



Model RC30S2 shown

Heavy Volume

Amana Commercial Microwave Model RC30S2

Power Output

- 3000 watts of power.
- 11 power levels for consistent, delicious results for frozen, refrigerated and fresh foods - from the freezer to table in minutes.
- Unique method of energy distribution provides superior even heating throughout the cavity.

Easy to Use

- Up to 100 programmable menu items simplifies cooking and ensures consistent results.
- Four stage cooking option with one-touch programming. Reduces prep time, labor and food waste while providing consistent results.
- Controls are user friendly and require minimal training.
- Multiple quantity pad calculates the proper cook times for up to 8 items.
- Automatic voltage sensor for easy installation.
- See-through door and lighted interior for monitoring without opening the door.
- Ample 1.0 cubic ft. (28 liter) capacity accommodates two standard 4" (102mm) deep half-sized pans.
- Interior ceramic shelf is sealed and recessed to reduce plate-to-shelf edge impact and keep spills contained.

Easy to Maintain

- Stainless steel exterior and interior for easy cleaning and a professional look.
- Constructed to withstand the foodservice environment.
- Removable, cleanable air filter and clean filter reminder protect oven components.
- Backed by the ACP, Inc. 24/7 ComServ Support Center, 866-426-2621.
- ETL Listed.

Heavy Volume

This category of microwave is ideal for...

Applications:

- Schools
- Grocery seafood departments
- Healthcare facilities
- Cafeteria/buffet operations

Through put potential:

- 1 lb. batch of spaghetti, 4 per hour
- 1 lb. batch of pre-cooked refrigerated mashed potatoes, 50 per hour
- Frozen corn on the cob, 80+ ears per hour
- 4 oz. portions of scrambled eggs, 9+ per hour

Defrost:

- Defrosts most frozen food products

All ACP, Inc. commercial ovens are backed by our Culinary Center. Call us with any question regarding food preparation, menu development and cooking times. 866-426-2621.



AIA File #:

Specification #:



Commercial Microwave Model RC30S2 | Heavy Volume

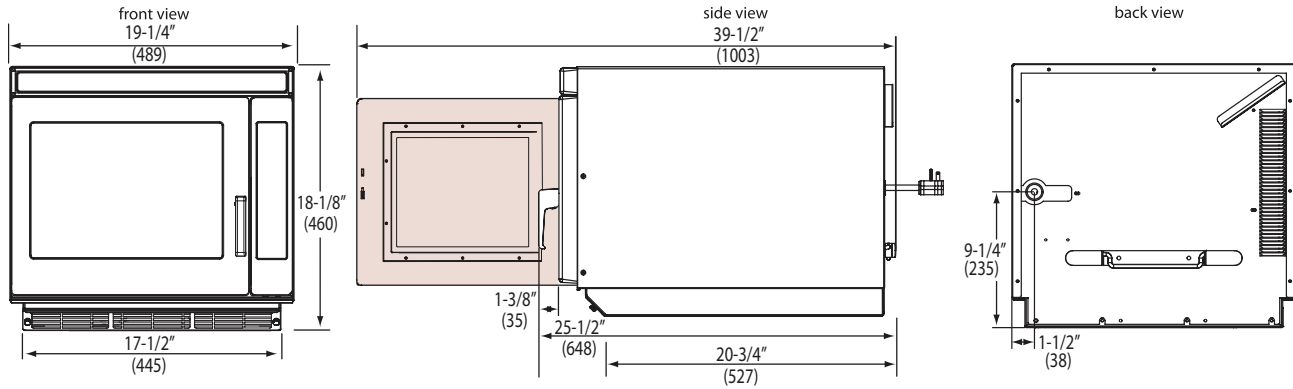

Installation Clearance: 1 1/2" (38.09) top and sides

Drawings available from KCL CADlog - techs@kclcad.com

Specification #:

Specifications			
Model	RC30S2		UPC Code 719881159539
Configuration	Countertop		
Control System	Touch		
Programmable Control Pads	10		
Settings Programmable	100		
Max. Cooking Time	60:00		
Power Levels	11		
Defrost	Yes, power level 2		
Time Entry Option	Yes, 3		
Microwave Distribution	Triple rotating antenna - two top, one bottom		
Magnetrons	3		
Display	LED		
Stage Cooking	Yes, 4		
Interior Light	Yes		
Door Opening	Lift and pull handle		
Pause Setting	Yes		
Signal	Adjustable, end of cycle		
Air Filter	Yes, removable, with clean filter reminder		
Call Service Alert	Yes		
Automatic Voltage Sensor	Yes		
Multiple Portion Setting	Yes, up to 8 items		
Exterior Dimensions	H 18 1/8" (460)	W 19 1/4" (489)	D** 25 1/2" (648)
Cavity Dimensions	H 8 1/2" (216)	W 13" (330)	D 15" (381)
Door Depth	40" (1016mm), 90°+ door open		
Usable Cavity Space	1.0 cubic ft. (28 liter)		
Exterior Finish	Stainless steel		
Interior Finish	Stainless steel with sealed-in ceramic shelf		
Power Consumption	4400 W, 21.2 A		
Power Output*	3000 W* Microwave		
Power Source	208 - 240V, 60 Hz, 30 A single phase		
Plug Configuration / Cord	NEMA 6-30	5 ft. (1.5m)	
Frequency	2450 MHz		
Product Weight	115 lbs. (52 kg.)		
Ship weight (approx.)	123 lbs. (56 Kg.)		
Shipping Carton Size	L 28 1/4" (718)	W 21 3/4" (553)	H 21 1/2" (546)

Specifications

Commercial microwave 10 touch pad control panel shall be programmable with the ability to program up to 100 menu items and shall have automatic cooking capability for up to eight portions. Cooking timer shall be 60 minute, countdown style with a time entry option and an adjustable end of cycle audible signal. LED display shall be a backlit. There shall be 11 power levels, 4 cooking stages and defrost mode at 20% power. Microwave output shall be 3000 watts distributed by three magnetrons each with a rotating antenna to provide superior even heating throughout the cavity. An automatic voltage sensor shall accommodate both 208 and 240 volts. Heavy duty door shall have a tempered glass window and a grab and pull handle with a 90°+ opening for easy access. An interior light shall facilitate monitoring without opening the door. The large 1.0 cubic ft. (28 liter) cavity shall accommodate two standard 4" (102 mm) deep half-sized pans. Interior ceramic shelf shall be sealed and recessed into the bottom of the cavity to reduce plate-to-shelf edge impact. Oven shall have a stainless steel interior and exterior for cleanability and a professional look. Oven shall have a removable, cleanable splatter shield. Air filter shall be easily accessible and removable from the front of the oven and have a "clean filter" reminder feature. A "call service alert" shall appear on display when service is needed. Microwave oven shall comply with standards set by the U.S. Department of Health and Human Services, ETL for safety and sanitation.



Warranty

Warranty Certificate for this product can be found on the ACP, Inc. website at:

www.acpsolutions.com/warranty



Service

All products are backed by the ACP, Inc. 24/7 ComServ Support Center.



AIA File #:

Measurements in () are millimeters

* IEC 60705 Tested

** Includes handle

