



DCM-300BAK

SANITARY CUBELET ICE MACHINE/DISPENSER



DCM-300BAK
08/13/25
Item # 13284K

Item #: _____
Project: _____
Qty: _____
AIA#: _____

Features

- ▶ Durable stainless steel exterior
- ▶ Advanced CleanCycle24™ design 
- ▶ Environmentally friendly R290 hydrocarbon refrigerant
- ▶ Stainless steel auger with greaseless bearing

- Up to 321 lbs. of ice production per 24 hours
- Built-in storage capacity of 1.3ft³/40 lbs.*
- 2 second flush cycle every hour
- Corrosion resistant stainless steel exterior
- Easy to chew, cubelet ice
- Self-contained design reduces opportunities for cross contamination
- Dispenses ice and water

Warranty:

3 Year Parts & Labor on entire machine.
5 Year Parts on Compressor; air-cooled condenser coil.
Valid in United States, Canada, Puerto Rico and U.S. Territories. Contact factory for warranty in other countries.
*Rated in accordance with AHRI Standard 820(I-P). Capacity based on 100% of total volume x 30 lb/ft³ average density of ice.

Ice Machine Shipping: (LxWxH) 33" x 25.25" X 46" Volume: 22.18ft³

W x D x H
26" x 22¹/₂" x 40"

SD-450
26¹/₄" x 22" x 32¹/₂"

SD-500
25⁷/₈" x 22" x 32³/₄"

DCM-300BAK
Air-Cooled
Shown with optional
SD-450 Stand



Condenser	Model	ICE PRODUCTION		WATER USAGE		ELECTRICAL							
		Air / Water Temp Lbs. per 24 hours 70°/ 50°F	90°/ 70°F	Potable Gal. per 100 lbs. 90°/ 70°F	Condenser Gal. per 100 lbs. 90°/ 70°F	kWh Used per 100 lbs. 90°/ 70°F	Min. Circuit/ Max. Fuse Size	Amperage	Voltage	Circuit Wires (including ground)	Heat Rejection BTU/hr.	Refrigerant Charge Amount	Net / Ship Weight (lbs.)
Air-Cooled	DCM-300BAK	343	240	12	N/A	6.0	20A	7.6A	115V/60/1	3	4,000	4.8 oz.	215 / 220

Cubelet Dimensions*

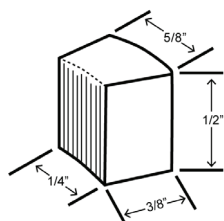

* approximate size in inches, image not to scale

Operating Limits

- Ambient Temp Range 45 - 100°F
- Water Temp Range 45 - 90°F
- Water Pressure 10 - 113 PSIG
- Voltage Range 108 - 127V
- If GFCI is required, a GFCI breaker MUST be used in lieu of GFCI receptacle

Service

- Allow 6" (15 cm) clearance at rear and sides for proper air circulation and ease of maintenance/ service should they be required. Allow 24" (61 cm) clearance at top to allow for removal of the auger.

Plumbing

- Icemaker Water Supply Line: Minimum 1/4" Nominal ID Copper Water Tubing or Equivalent
- Icemaker Drain Line: Minimum 3/4" Nominal ID Hard Pipe or Equivalent

Water Filter

Please refer to water filter specification sheet for recommendations.

Hoshizaki reserves the right to change specifications without notice.



DCM-300BAK

SANITARY CUBELET ICE MACHINE/DISPENSER

DCM-300BAK
08/13/25
Item # 13284K

inch
[mm]

FRONT VIEW

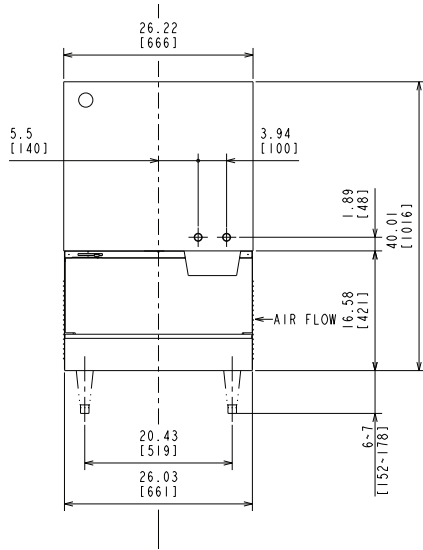

SIDE VIEW

Front
→

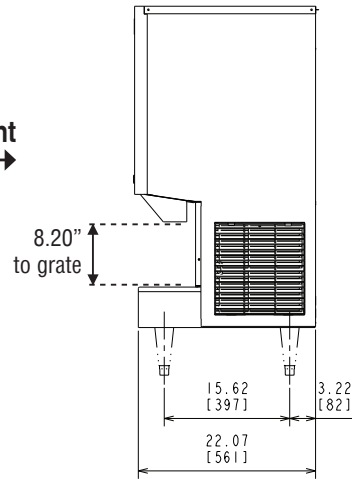

REAR VIEW

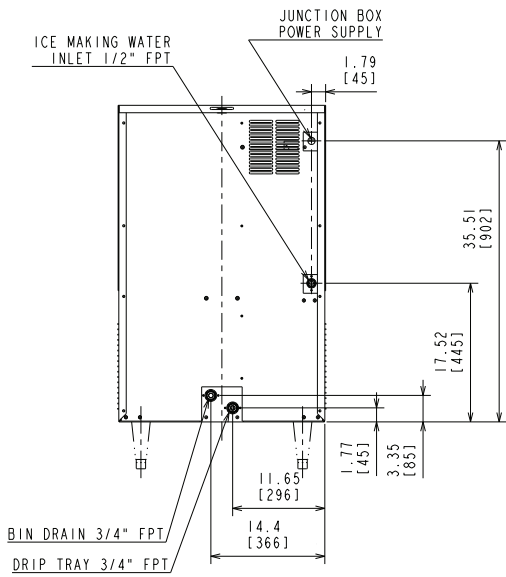

TOP VIEW

